



The Connoisseur

The handle that started it all

When Fab&Fix set out to develop the ultimate in window and door hardware, the Connoisseur inline espag handle was the first result.

True to our principles of Form & Function, its technical excellence was matched by the first sweeping curves seen on a product of this type. Only available in white at launch, it's become a testament to the longevity of our design.

Now available in inline, offset and cranked variants, in a wide range of colour finishes, over 15 million Connoisseur handles are installed in homes around the world.

 **National**
Seal Systems
Limited



Unit 210 Holly Road, Western Industrial Estate.

Naas Road, Dublin 12

Ph 00353-1-4565170 Fax 00353-1-4502371

Email: info@nationalseal.ie web: www.nationalseal.ie



Hardex Electro* test results versus industry norms

TEST	HARDEX ELECTRO*	INDUSTRY NORM
Corrosion Resistance	1,000 hours	240 hours
UV Light Resistance	500 hours	120 hours
Abrasion Resistance	18 litres of sand	5 litres of sand
Smear Resistance	1,000 double rubs	100 double rubs
Sweat Resistance	4 passes	Zero passes
Acetone Rub	500 times	No data
Adhesion Cross Cut Check	1mm for 100 squares	No data
Pencil Hardness	4N - 5N	2N - 3N

*The tests were carried out on Hardex Gold finish

The Connoisseur

Key clicks into place and won't fall out, even when pivoting the lever

Solid die-cast construction gives a sturdy feel

Long handle with 50mm window clearance for easy operation

Patented bi-material cover caps with colour co-ordinated finish

Classic design with a contemporary twist

Heavy duty sprung latching wedge gives a positive click on closing

40mm slotted spindle available for easy cropping



The E Series

Connoisseur Inline Locking



Features & Benefits

- Solid die cast zinc construction
Heavyweight handle with sturdy feel
- Heavy duty sprung latching wedge
Positive click on closing
- Long handle with 43mm window clearance
Greater leverage and easy to operate without catching a hand on the window
- Classic design with a contemporary twist
Create an elegant and stylish window
- Patented cover caps with colour coordinated finish
Perfectly matching components, even down to the smallest details

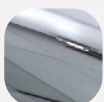
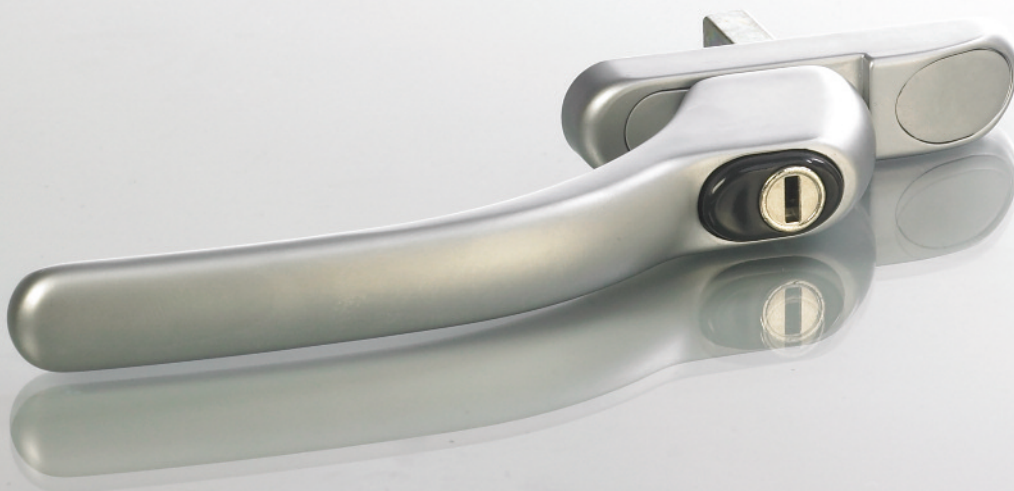

Hardex
Chrome

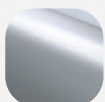

Hardex
Satin

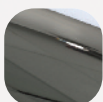

Hardex
Bronze

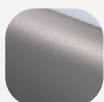

Hardex
Smoke

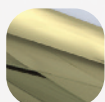

Hardex
Gold

Fab&Fix

Connoisseur Inline Locking

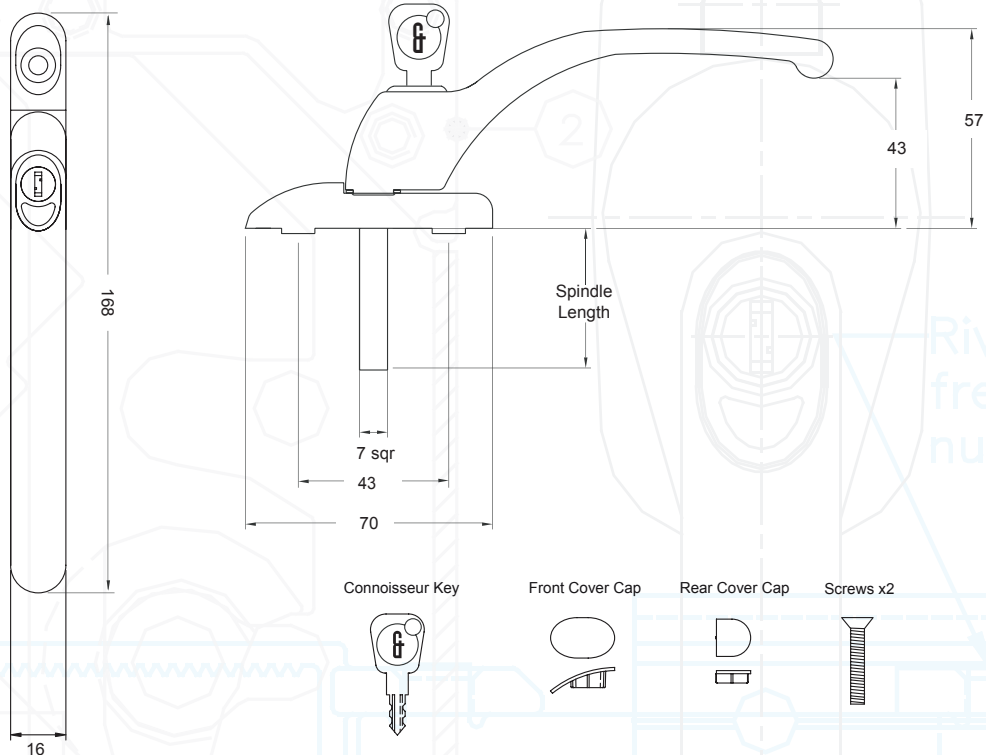

Rivet on item
free movement
numbers 2 a

All dimensions are shown in millimetres

Additional Benefits

- **Secured by Design**
Additional peace of mind
- **Key clicks into place when inserted**
Won't fall out of the lock, even when pivoting the lever
- **Slotted spindle (40mm version only)**
Allows cropping to 5mm increments

Technical Specification

Designed for PVC-U and Timber windows
 Certified to BS 7950: 1997
 All finishes salt spray tested to 480 hours
 (BS EN 1670:Class 5)
 Tested to 50,000 cycles

Product Codes

Connoisseur Inline Locking

Spindle	Hardex Chrome	Hardex Satin	Hardex Bronze	Hardex Smoke	Hardex Gold
10mm	0C021	0C022	0C023	0C024	0C025
15mm	0C041	0C042	0C043	0C044	0C045
20mm	0C061	0C062	0C063	0C064	0C065
25mm	0C081	0C082	0C083	0C084	0C085
30mm	0C101	0C102	0C103	0C104	0C105
35mm	0C121	0C122	0C123	0C124	0C125
40mm	0C141	0C142	0C143	0C144	0C145

The E Series

Connoisseur Inline Non-Locking



Features & Benefits

- Solid die cast zinc construction
Heavyweight handle with sturdy feel
- Heavy duty sprung latching wedge
Positive click on closing
- Long handle with 43mm window clearance
Greater leverage and easy to operate without catching a hand on the window
- Classic design with a contemporary twist
Create an elegant and stylish window
- Patented cover caps with colour coordinated finish
Perfectly matching components, even down to the smallest details

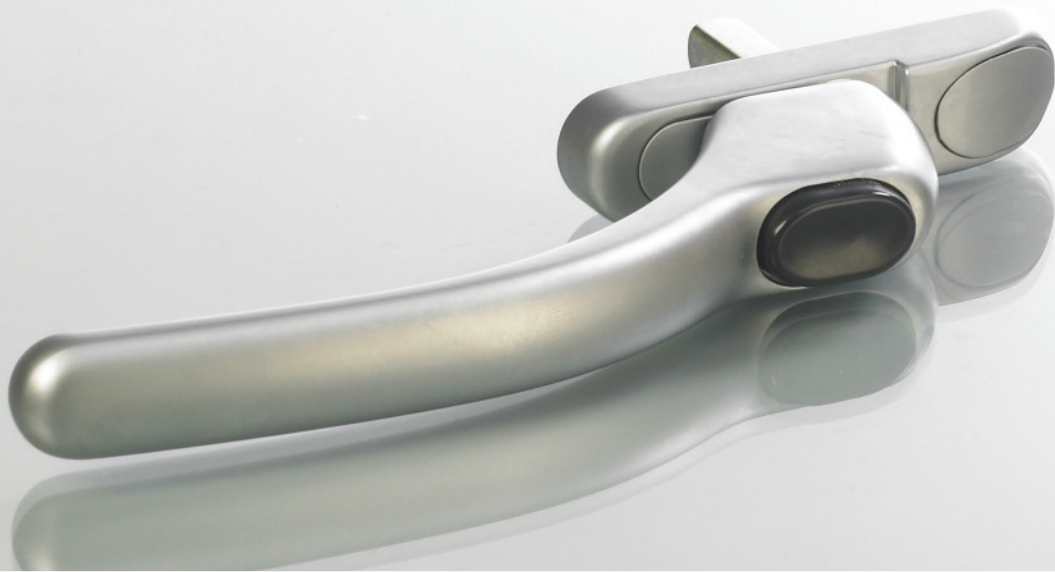

Hardex
Chrome

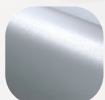

Hardex
Satin

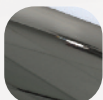

Hardex
Bronze



Hardex
Smoke

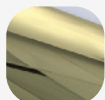

Hardex
Gold

Fab&Fix

Connoisseur Inline Non-Locking

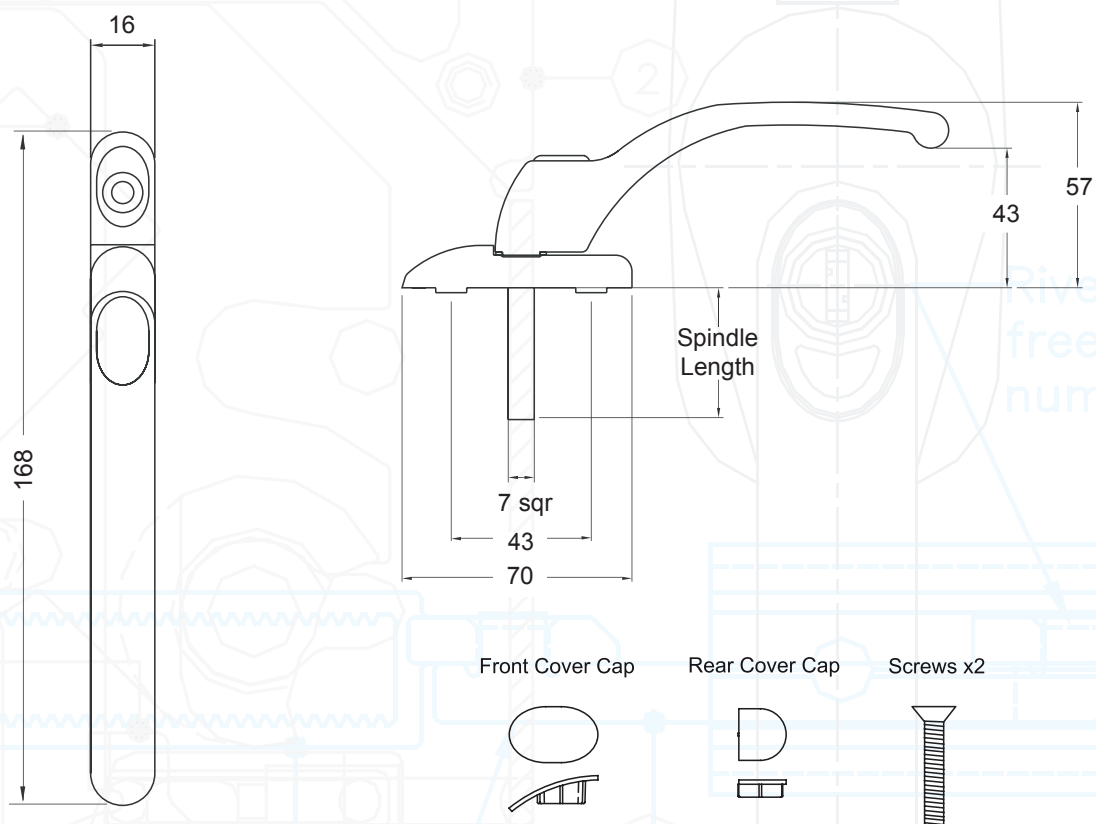

All dimensions are shown in millimetres

Additional Benefits

- **Dedicated non-locking handle**
Conforms to building regulations for non-locking windows
- **Slotted spindle (40mm version only)**
Allows cropping to 5mm increments

Technical Specification

Designed for PVC-U and Timber windows
 Certified to BS 7950:1997
 All finishes salt spray tested to 480 hours
 (BS EN 1670: Class 5)
 Tested to 50,000 cycles

Product Codes

Connoisseur Inline Non-Locking

Spindle	Hardex Chrome	Hardex Satin	Hardex Bronze	Hardex Smoke	Hardex Gold
30mm	0C361	0C362	0C363	0C364	0C365
40mm	0C381	0C382	0C383	0C384	0C385

The E Series

Connoisseur Cranked Locking



Features & Benefits

- Solid die cast zinc construction
Heavyweight handle with sturdy feel
- Heavy duty sprung latching wedge
Positive click on closing
- Long handle with 43mm window clearance
Greater leverage and easy to operate without catching a hand on the window
- Classic design with a contemporary twist
Create an elegant and stylish window
- Patented cover caps with colour coordinated finish
Perfectly matching components, even down to the smallest details

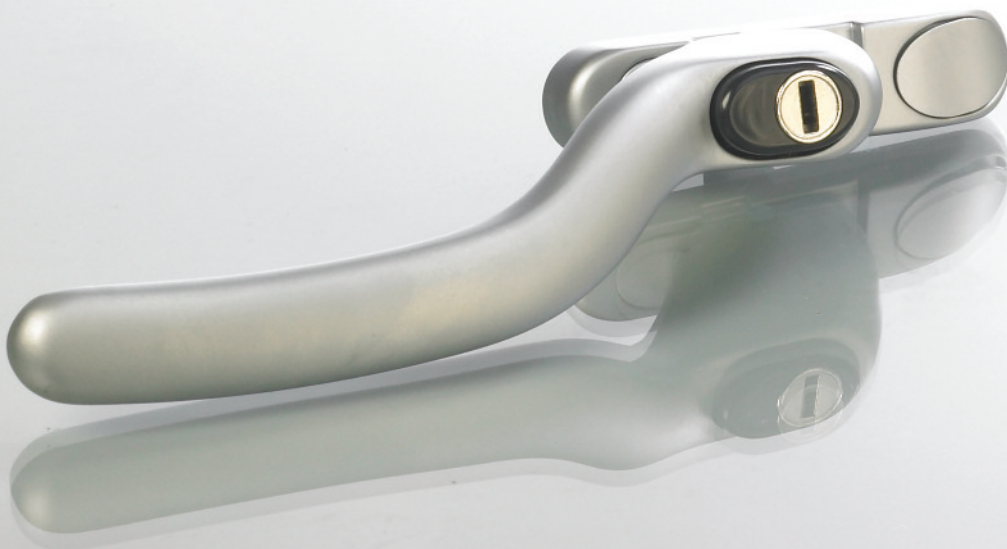

White

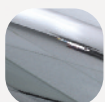

Hardex
Chrome



Hardex
Satin

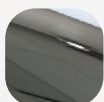

Hardex
Bronze

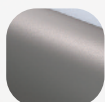

Hardex
Smoke

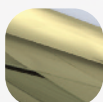

Hardex
Gold

Fab&Fix

Connoisseur Cranked Locking

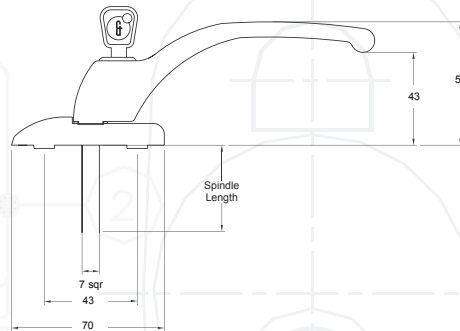
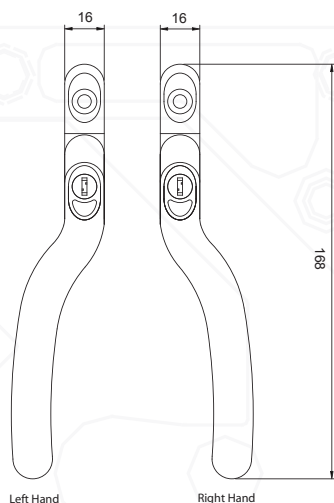

Front Cover Cap Rear Cover Cap Connoisseur Key Screws x2



All dimensions are shown in millimetres

Additional Benefits

- **Secured by Design**
Additional peace of mind
- **Key clicks into place when inserted**
Won't fall out of the lock, even when pivoting the lever
- **Slotted spindle (40mm version only)**
Allows cropping to 5mm increments

Technical Specification

Designed for PVC-U and Timber windows
 Certified to BS 7950: 1997
 All finishes salt spray tested to 480 hours
 (BS EN 1670: Class 5)
 Tested to 50,000 cycles

Product Codes

Connoisseur Cranked Locking Right Handed

Spindle	White	Hardex Chrome	Hardex Satin	Hardex Bronze	Hardex Smoke	Hardex Gold
10mm	0F020	0F021	0F022	0F023	0F024	0F025
15mm	0F040	0F041	0F042	0F043	0F044	0F045
20mm	0F060	0F061	0F062	0F063	0F064	0F065
25mm	0F080	0F081	0F082	0F083	0F084	0F085
30mm	0F100	0F101	0F102	0F103	0F104	0F105
35mm	0F120	0F121	0F122	0F123	0F124	0F125
40mm	0F140	0F141	0F142	0F143	0F144	0F145

Connoisseur Cranked Locking Left Handed

Spindle	White	Hardex Chrome	Hardex Satin	Hardex Bronze	Hardex Smoke	Hardex Gold
10mm	0F320	0F321	0F322	0F323	0F324	0F325
15mm	0F340	0F341	0F342	0F343	0F344	0F345
20mm	0F360	0F361	0F362	0F363	0F364	0F365
25mm	0F380	0F381	0F382	0F383	0F384	0F385
30mm	0F400	0F401	0F402	0F403	0F404	0F405
35mm	0F420	0F421	0F422	0F423	0F424	0F425
40mm	0F440	0F441	0F442	0F443	0F444	0F445

The E Series

Connoisseur Cranked Non-Locking



Features & Benefits

- Solid die cast zinc construction
Heavyweight handle with sturdy feel
- Heavy duty sprung latching wedge
Positive click on closing
- Long handle with 43mm window clearance
Greater leverage and easy to operate without catching a hand on the window
- Classic design with a contemporary twist
Create an elegant and stylish window
- Patented cover caps with colour coordinated finish
Perfectly matching components, even down to the smallest details

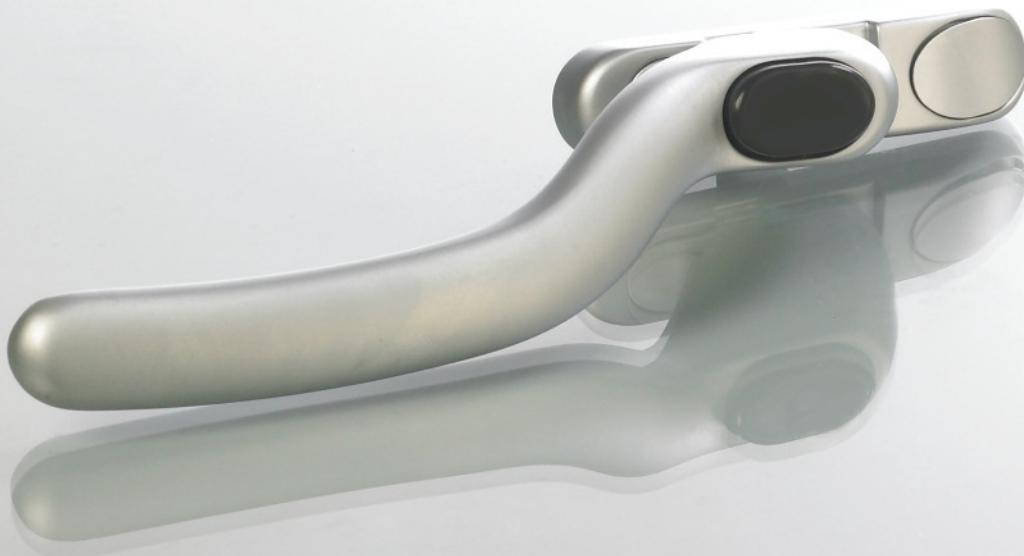

White

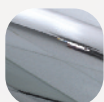

Hardex
Chrome

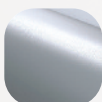

Hardex
Satin

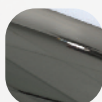

Hardex
Bronze



Hardex
Smoke

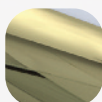

Hardex
Gold

Fab&Fix

Connoisseur Cranked Non-Locking

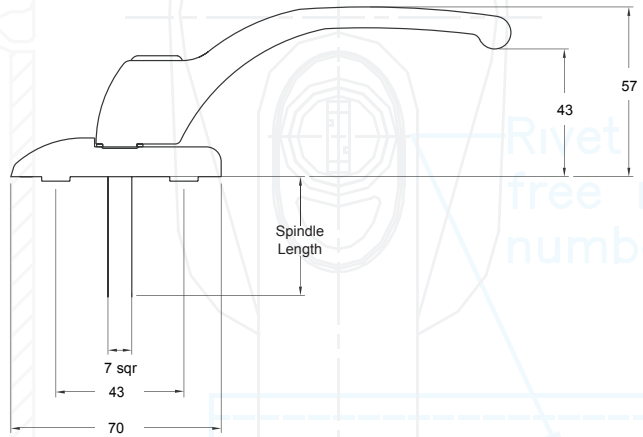
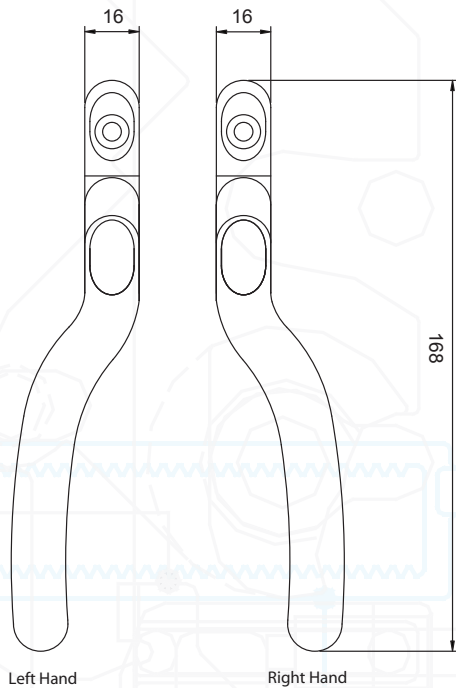

Front Cover Cap Rear Cover Cap Screws x2

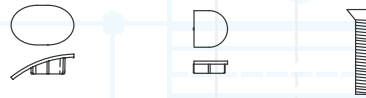

All dimensions are shown in millimetres

Additional Benefits

- **Dedicated non-locking handle**
Conforms to building regulations for non-locking windows
- **Slotted spindle (40mm version only)**
Allows cropping to 5mm increments

Technical Specification

Designed for PVC-U and Timber windows
Certified to BS 7950: 1997
All finishes salt spray tested to 480 hours
(BS EN 1670: Class 5)
Tested to 50,000 cycles

Product Codes

This is a special order item, please contact us for product codes